

Specifications

Nominal Voltage		12 V
Rated capacity(20HR)		1.9Ah
Dimension	Length	178 ± 2mm (7.01inch)
	Width	34 ± 1mm (1.34inch)
	Height	60 ± 1mm (2.36inch)
	Total Height	66 ± 1mm (2.60inch)
Approx. Weight		0.78kg (1.72lbs) ± 5%

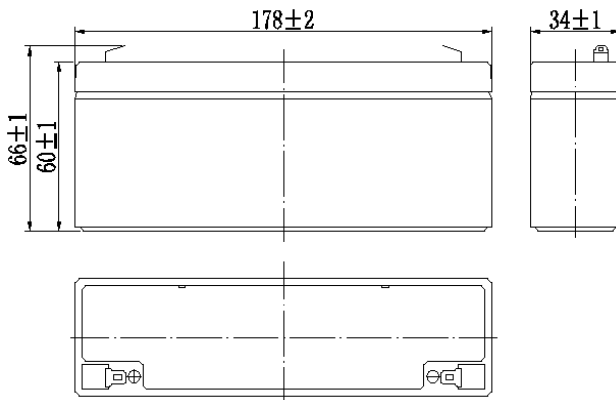

Dimensions



Terminal

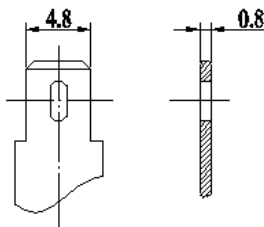

Characteristics

Capacity (25°C)	20HR(10.5V)	1.9Ah
	10HR(10.5V)	1.8Ah
	1HR(9.60V)	1.2Ah
Terminal type		T1
Internal resistance (Fully charged, 25°C)		Approx.65mΩ
Capacity affected by temperature (20HR)	40°C	102%
	25°C	100%
	0°C	85%
	-15°C	65%
Self-discharge (25°C)	3 month	Remaining Capacity: 91%
	6 month	Remaining Capacity: 82%
	12 month	Remaining Capacity: 65%
Nominal operating temperature		25°C ± 3°C (77°F ± 5°F)
Operating temperature range	Discharge	-15°C ~ 50°C (5°F ~ 122°F)
	Charge	-10°C ~ 50°C (14°F ~ 122°F)
	Storage	-20°C ~ 50°C (-4°F ~ 122°F)
Float charging voltage(25°C)	13.50 to 13.80V Temperature compensation: -18mV/°C	
Cyclic charging voltage(25°C)	14.50 to 15.00V Temperature compensation: -30mV/°C	
Maximum charging current	0.57A	
Maximum discharge current	28.5A(5 sec.)	
Designed floating life(20°C)	5 years	

Construction

Component	Positive plate	Negative plate	Container	Cover	Separator	Electrolyte	Safety valve	Terminal
Raw material	Lead dioxide	Lead	ABS	ABS	AGM	Sulfuric acid	Rubber	Copper

Constant Current Discharge Characteristics (A, 25°C)

F.V/TIME	5min	10min	15min	30min	60min	2h	3h	4h	5h	10h	20h
9.60V	7.26	4.60	3.59	2.02	1.24	0.68	0.47	0.39	0.33	0.18	0.096
9.90V	7.04	4.46	3.50	1.98	1.23	0.68	0.47	0.39	0.33	0.18	0.096
10.2V	6.75	4.28	3.38	1.92	1.19	0.67	0.46	0.38	0.33	0.18	0.096
10.5V	6.46	4.09	3.26	1.88	1.17	0.66	0.46	0.38	0.32	0.18	0.095
10.8V	6.10	3.86	3.09	1.81	1.13	0.64	0.45	0.37	0.32	0.17	0.093

Constant Power Discharge Characteristics (Watt, 25°C)

F.V/TIME	5min	10min	15min	30min	60min	2h	3h	4h	5h	10h	20h
9.60V	81.0	51.9	40.9	23.2	14.4	7.96	5.59	4.64	3.96	2.16	1.16
9.90V	78.6	50.3	40.0	22.7	14.2	7.92	5.56	4.61	3.93	2.15	1.15
10.2V	75.3	48.2	38.5	22.0	13.8	7.85	5.52	4.58	3.91	2.14	1.15
10.5V	72.1	46.2	37.2	21.5	13.6	7.73	5.48	4.55	3.88	2.13	1.14
10.8V	68.0	43.6	35.2	20.7	13.1	7.53	5.32	4.41	3.76	2.08	1.12

Note: The above characteristics data can be obtained within three charge/discharge cycles.

Discharge Characteristics (25°C)

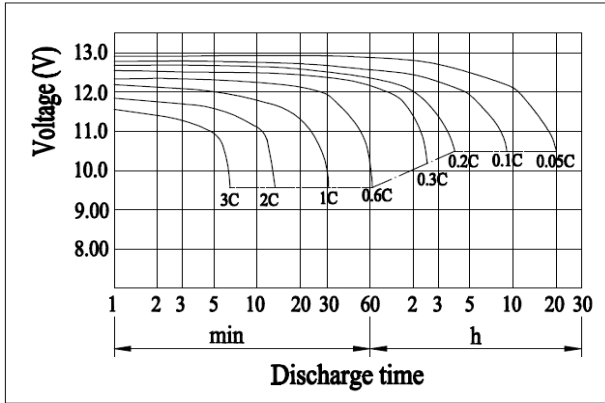

Charging Characteristics (25°C)

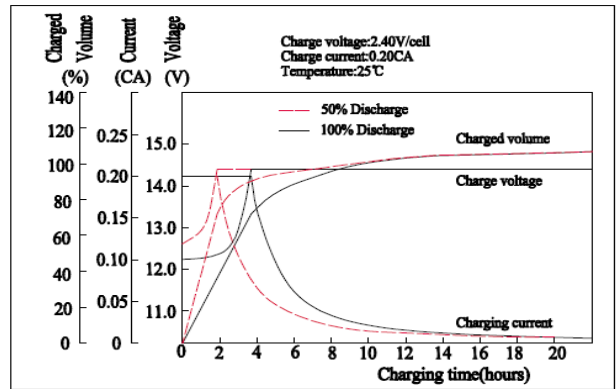

Effect of Temperature on Capacity

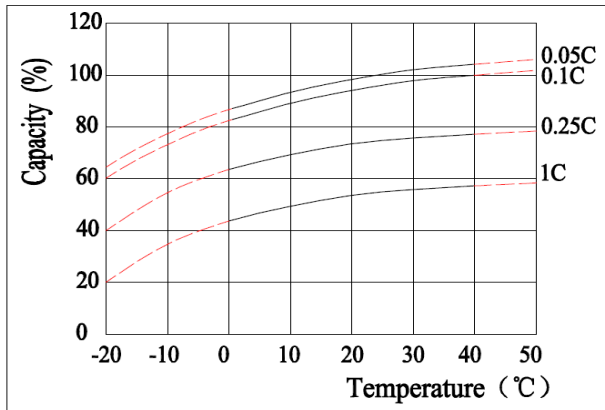

Self-discharge Characteristics

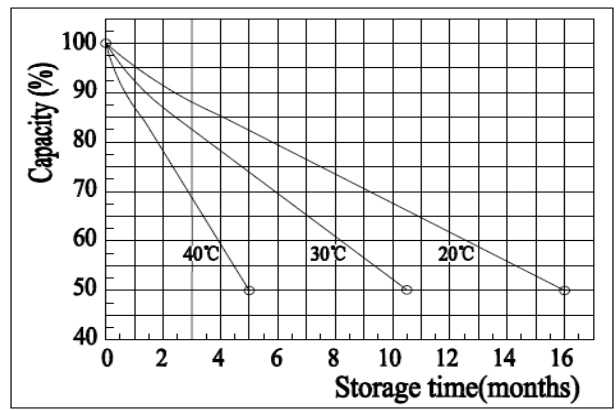

Floating Life on Temperature

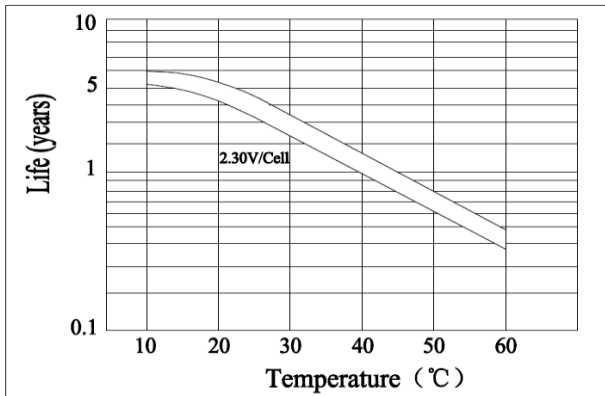

Cycle Life on D.O.D (25°C)

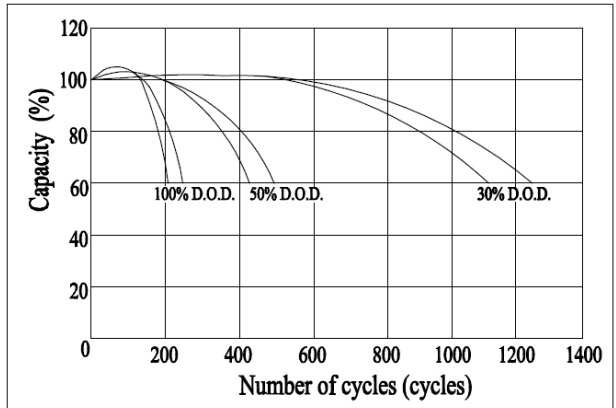

The Relationship for Open Circuit Voltage and Residual Capacity (25°C)

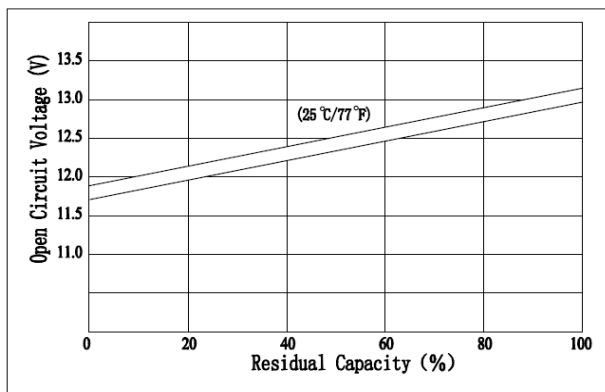

The Relationship for Charging Voltage and Temperature

