

KB1280EV 12V 77Ah C₃

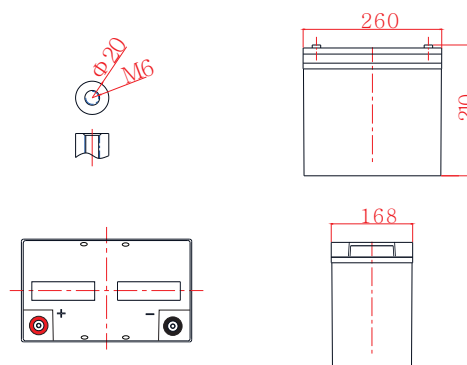

The Electric Vehicle batteries were developed based on a specialized grid as well as active material. These batteries have anchored plates and a high impact reinforced polypropylene case which can withstand the most extreme environments and vibrations. The KB EV series is constituted of batteries of several different sizes so that they may be used for many different applications. The KB EV series uses dry cell technology that allows for a superior performance and an unparalleled quality and reliability. Through the use of the dry cell technology this series was designed for sensitive environments that require improved life cycles for commercial, industrial, residential and private applications. Without any need for maintenance and with an advanced construction the EV series is an excellent option for many applications.

Dimensions and Terminal (Unit: mm (inches))



Performance Characteristics

Nominal Voltage	12V	
Dimensions	Length (mm / inch)	260 / 10.2
	Width (mm / inch)	168 / 6.61
	Height (mm / inch)	210 / 8.27
	Total Height (mm / inch)	210 / 8.27
Approx. Weight (Kg / lbs)	25.2 / 55.69	
Design Life	5 years	
Terminal	M6	
Container Material	ABS	
Rated Capacity	90.0 Ah / 9.00 A	(10hr, 1.75V / cell, 20°C / 77°F)
	77.1 Ah / 25.7 A	(3hr, 1.75V / cell, 20°C / 77°F)
	63.2 Ah / 63.2 A	(1hr, 1.75V / cell, 20°C / 77°F)
Operating Temp. Range	Discharge : -20 ~ 50°C (-4 ~ 122°F)	
	Charge : -20 ~ 50°C (-4 ~ 122°F)	
	Storage : -20 ~ 50°C (-4 ~ 122°F)	
Charge Method	Float use: 13.7~13.9V at 25°C (77°F), recom 13.8V	
	Cycle use: 14.7~14.9V at 25°C (77°F), recom 14.7V	
	Max charge current 16.0A	
Self Discharge	Fully charged Kaise Electric Vehicle batteries may be stored for up to 6 months at 25°C (77°F) and then a freshening charge is required. For higher temperatures the time interval will be shorter.	

Applications

- Electric wheelchair
- Electric vehicle / golf car
- Electric toys
- Renewable energies
- Marine equipment

Certifications

ISO 9001:2008 ISO 14001:2008



Discharge Current vs. Discharge Voltage

Final discharge voltage V/CELL	1.8	1.75	1.7	1.6
Discharge current (A)	I ≤ 0.1CA	0.25CA ≥ I > 0.1CA	0.55CA ≥ I > 0.25CA	I > 0.55CA

Constant Current Discharge (Amperes) at 25°C (77°F)

Volts/cell	5min	15min	30min	1h	2h	3h	10h	20h
1.80V	261	156	102	61.6	35.6	26.0	8.91	4.77
1.75V	291	168	107	63.2	36.3	25.7	9.00	4.80
1.70V	317	174	107	64.2	36.8	26.0	9.11	4.82
1.65V	330	177	109	64.7	37.1	26.4	9.19	5.85
1.60V	340	183	111	65.0	37.3	26.6	9.28	5.87

Constant Power Discharge (Watts per cell) at 25°C (77°F)

Volts/cell	5min	15min	30min	1h	2h	3h	10h	20h
1.80V	468	294	194	119	69.5	51.1	17.7	9.75
1.75V	509	311	198	120	69.7	51.3	17.8	9.80
1.70V	546	313	199	121	70.1	51.6	18.0	9.84
1.65V	549	316	199	122	70.3	51.9	18.2	9.89
1.60V	571	322	201	123	70.5	52.6	18.4	9.94

(Note) The above characteristics data are average values obtained within three charge/discharge cycles not the minimum values.

Discharging Characteristic

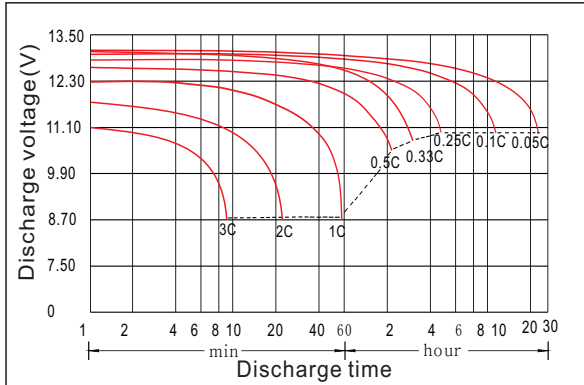

Charging Characteristics

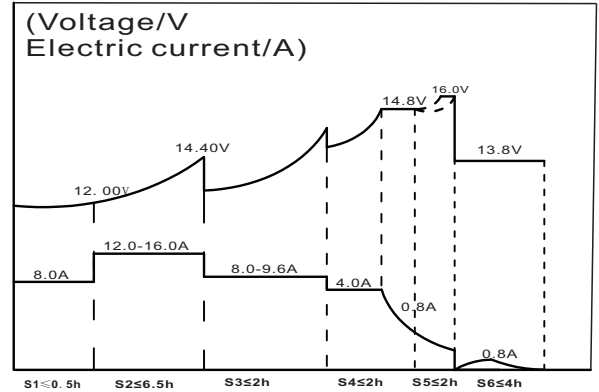

The effect of discharge depth on cycle life

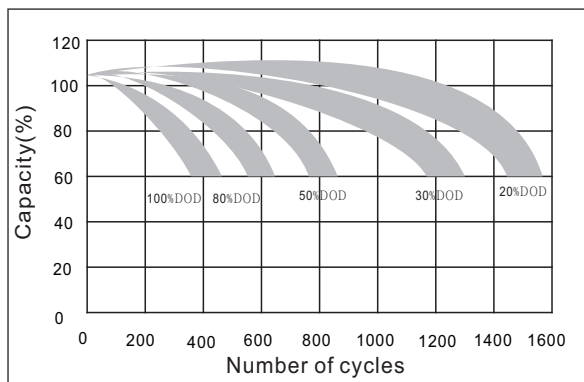

Temperature Effects on Capacity

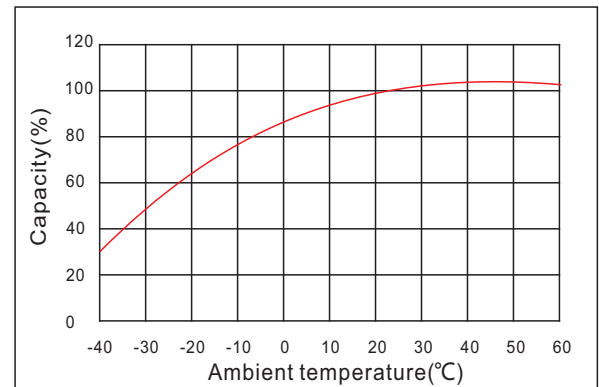

Curves of self-discharge

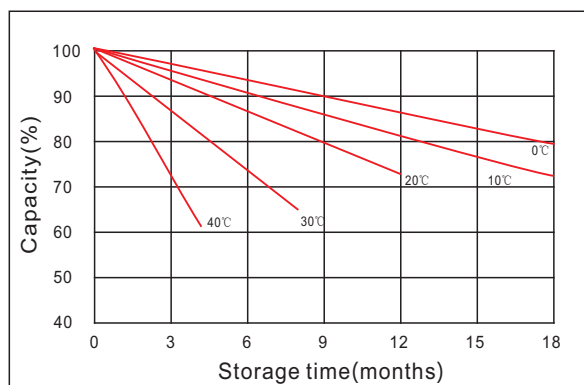

Curves of open circuit voltage vs. capacity

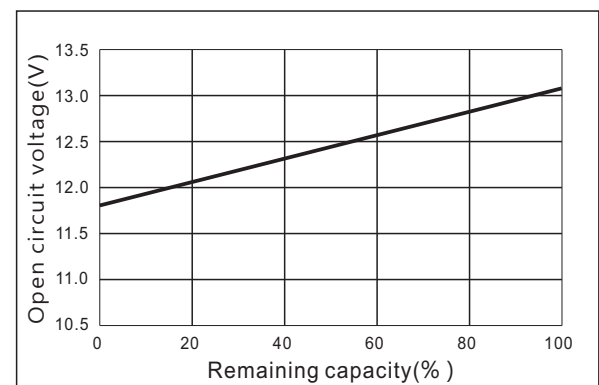

IMPORTANT NOTE: The specifications presented herein are subject to revision without notice.